

OR

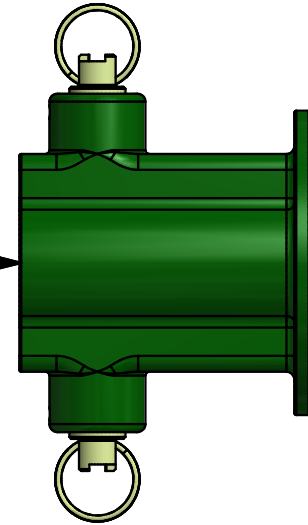

*** * NOTES * ***

1. MAT'L:
 TOOL BODY: CAST STEEL
 SS ADAPTER: CAST STEEL
 PIN ASSEMBLIES: AISI 4140
2. FINISH:
 TOOL BODY: PAINTED SPRUCE GREEN
 SS ADAPTER: PAINTED SPRUCE GREEN

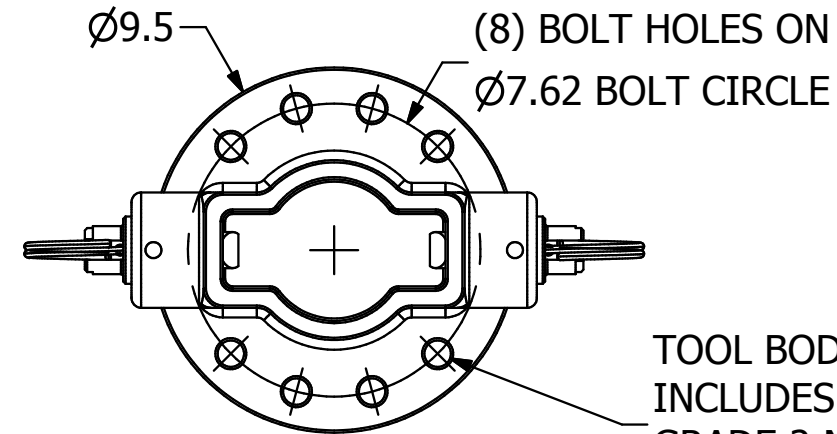
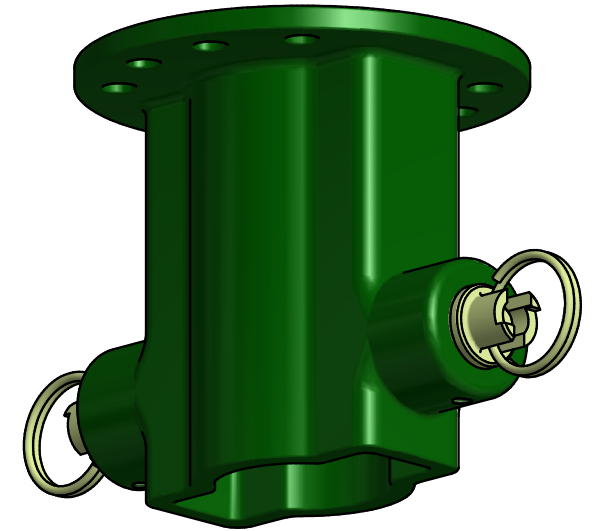

TOOL BODY INCLUDES (8) 5/8" GRADE 2 NUTS, GRADE 2 BOLTS, AND LOCKWASHERS

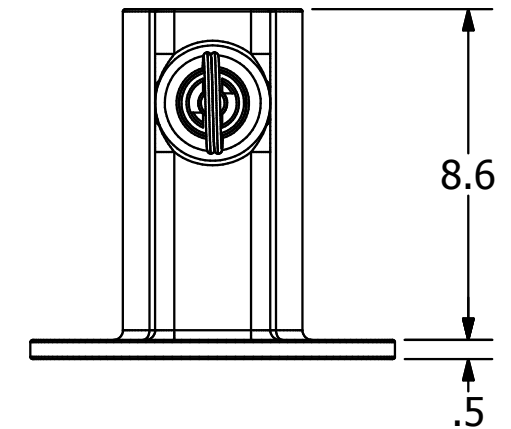
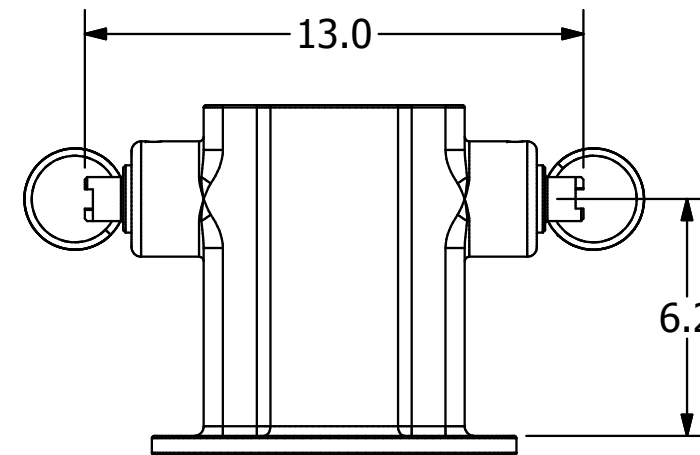

CATALOG NUMBER	FAMILY	INCLUDES
C3031624	RS2875	PIN ASSEMBLY
C3031626	RS2875	TOOL BODY & PIN ASSEMBLY
C3031620	RS3500	PIN ASSEMBLY
C3031627	RS3500	TOOL BODY & PIN ASSEMBLY
C3031790	RS3500 BUILDING CODE	PIN ASSEMBLY
C3031691	SS5/150, SS175, RS2875	SS ADAPTER
C3031692	SS5/150, SS175, RS2875	SS ADAPTER & PIN ASSEMBLY
C3031658	-----	LOCKING DOG REPLACEMENT KIT
056653P	-----	5/8" GRADE 2 BOLT (QTY 1)
055827P	-----	5/8" SPRING LOCKWASHER (QTY 1)
055803P	-----	5/8" GRADE 2 HEX NUT (QTY 1)

CHANCE®		HUBBELL POWER SYSTEMS, Inc.	
CONFIDENTIAL: THIS DRAWING AND ITS CONTENTS ARE CONFIDENTIAL AND THE EXCLUSIVE PROPERTY OF HUBBELL POWER SYSTEMS. NO PUBLICATION, DISTRIBUTION OR COPIES MAY BE MADE WITHOUT THE WRITTEN CONSENT OF HUBBELL POWER SYSTEMS. HUBBELL POWER SYSTEMS UNPUBLISHED ALL RIGHTS RESERVED UNDER THE COPYRIGHT LAWS.		UNIVERSAL DRIVE TOOL	
TITLE	SIZE	CAT / PART / ASSY NO.	DWG NO.
	SB	SEE CHART	SA3031620
DO NOT SCALE THIS DRAWING	DRN BY TMK	DATE 10/25/12	SHEET 1 / 2
			REV E

RS3500 PIN ASSEMBLY

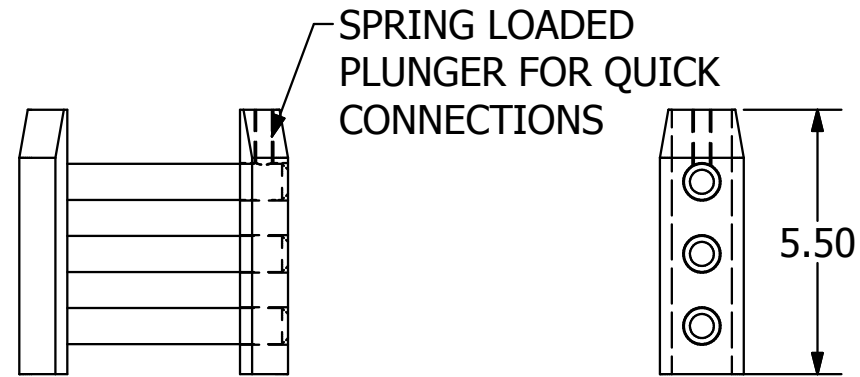
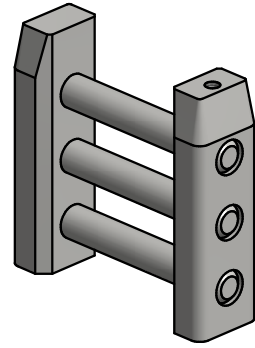
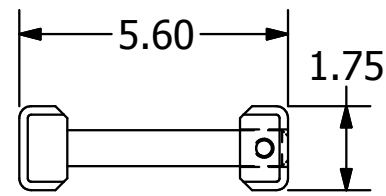

SS ADAPTER

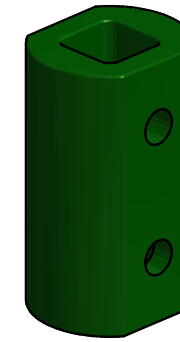
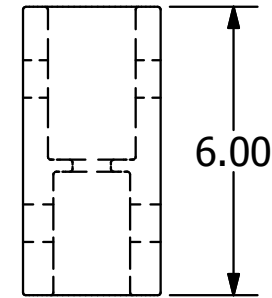

* REQUIRES RS2875 PIN ASSEMBLY TO FUNCTION & LOCK IN SS SHAFT

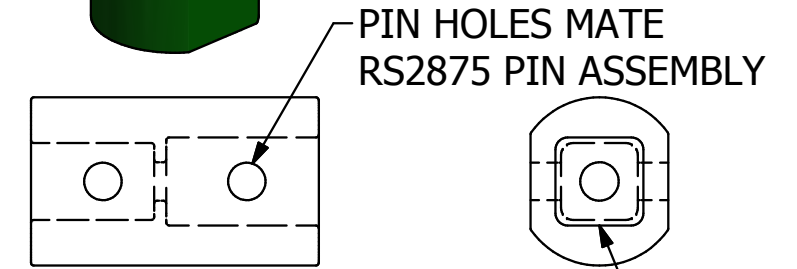
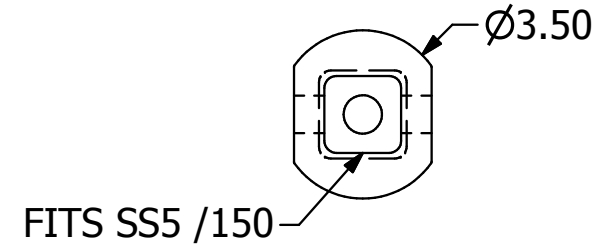

RS3500 BUILDING CODE PIN ASSEMBLY

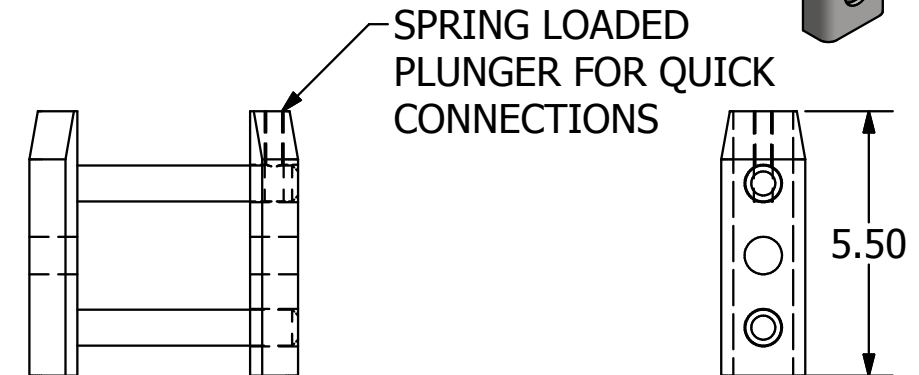
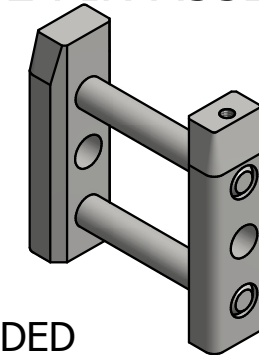
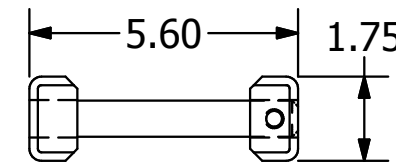

RS2875 PIN ASSEMBLY

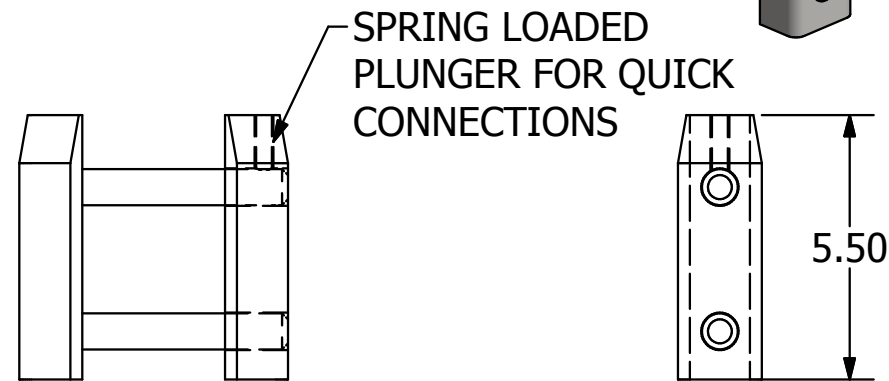
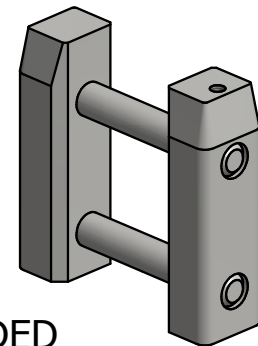
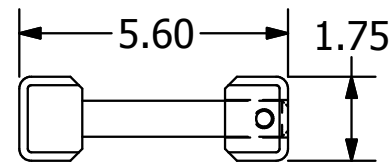

CHANCE®



HUBBELL POWER SYSTEMS, Inc.

CONFIDENTIAL: THIS DRAWING AND ITS CONTENTS ARE CONFIDENTIAL AND THE EXCLUSIVE PROPERTY OF HUBBELL POWER SYSTEMS. NO PUBLICATION, DISTRIBUTION OR COPIES MAY BE MADE WITHOUT THE WRITTEN CONSENT OF HUBBELL POWER SYSTEMS. HUBBELL POWER SYSTEMS UNPUBLISHED ALL RIGHTS RESERVED UNDER THE COPYRIGHT LAWS.

TITLE
UNIVERSAL DRIVE TOOL

SIZE SB	CAT / PART / ASSY NO. SEE CHART	DWG NO. SA3031620	REV E
DO NOT SCALE THIS DRAWING	DRN BY TMK	DATE 10/25/12	SHEET 2 / 2